

# JMSH0401MGQ

## Features

- Ultra-low ON-resistance,  $R_{DS(ON)}$
- Low Gate Charge
- 100% UIS Tested
- 100%  $V_{ds}$  Tested
- Halogen-free; RoHS-compliant
- AEC-Q101 Qualified

## Applications

- Load Switch
- PWM Application
- General A Application

## Product Summary

Parameters	Value	Unit
$V_{DSS}$	40	V
$V_{GS(th)\_Typ}$	2.7	V
$I_D(@V_{GS}=10V)$	223	A
$R_{DS(ON)\_Typ}(@V_{GS}=10V)$	1.4	m $\Omega$

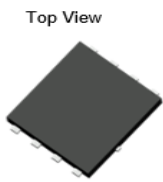

PDFN5X6-8L

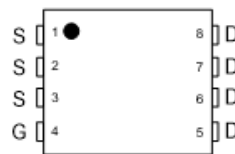
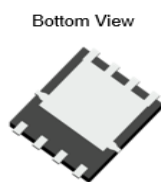

Pin Assignment

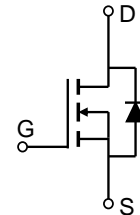

Schematic Diagram

## Ordering Information

Device	Marking	MSL	Form	Package	Reel(pcs)	Per Carton (pcs)
JMSH0401MGQ-13	SH0401MQ	1	Tape&Reel	PDFN5x6-8L	5000	50000

## Absolute Maximum Ratings (@ $T_C = 25^\circ\text{C}$ unless otherwise specified)

Symbol	Parameter	Value	Unit
$V_{DS}$	Drain-to-Source Voltage	40	V
$V_{GS}$	Gate-to-Source Voltage	$\pm 20$	V
$I_D$	Continuous Drain Current	$T_C = 25^\circ\text{C}$	223
		$T_C = 100^\circ\text{C}$	158
$I_{DM}$	Pulsed Drain Current <sup>(1)</sup>	Refer to Fig.4	A
$E_{AS}$	Single Pulsed Avalanche Energy <sup>(2)</sup>	459	mJ
$P_D$	Power Dissipation	$T_C = 25^\circ\text{C}$	157
		$T_C = 100^\circ\text{C}$	78
$T_{J\_STG}$	Junction & Storage Temperature Range	-55 to 175	$^\circ\text{C}$

## Thermal Characteristics

Symbol	Parameter	Max	Unit
$R_{\theta 90}$	Thermal Resistance, Junction to Ambient <sup>(3)</sup>	42	$^\circ\text{C/W}$
$R_{\theta 92}$	Thermal Resistance, Junction to Case	1.0	

**Electrical Characteristics** ( $T_J = 25^\circ\text{C}$  unless otherwise specified)

Symbol	Parameter	Conditions	Min.	Typ.	Max.	Unit
<b>Off Characteristics</b>						
$V_{(BR)DSS}$	Drain-Source Breakdown Voltage	$I_D = 250\mu\text{A}$ , $V_{GS} = 0\text{V}$	40	-	-	V
$I_{DSS}$	Zero Gate Voltage Drain Current	$V_{DS} = 32\text{V}$ , $V_{GS} = 0\text{V}$	-	-	1.0	$\mu$
$I_{GSS}$	Gate-Body Leakage Current	$V_{DS} = 0\text{V}$ , $V_{GS} = \pm 20\text{V}$	-	-	$\pm 100$	
<b>On Characteristics</b>						
$V_{GS(th)}$	Gate Threshold Voltage	$V_{DS} = V_{GS}$ , $I_D = 250\mu\text{A}$	1.9	2.7	3.5	V
$R_{DS(ON)}$	Static Drain-Source ON-Resistance <sup>(4)</sup>	$V_{GS} = 10\text{V}$ , $I_D = 20\text{A}$	-	1.4	1.7	m $\Omega$
<b>Dynamic Characteristics</b>						
$R_g$	Gate Resistance	$f = 1\text{MHz}$	-	0.9	-	$\Omega$
$C_{iss}$	Input Capacitance	$V_{GS} = 0\text{V}$ , $V_{DS} = 20\text{V}$ , $f = 1\text{MHz}$	2589	3625	4893	pF
$C_{oss}$	Output Capacitance		1413	1979	2671	pF
$C_{riss}$	Reverse Transfer Capacitance		113	158	213	pF
$Q_g$	Total Gate Charge	$V_{GS} = 0$ to $10\text{V}$ $V_{DS} = 20\text{V}$ , $I_D = 20\text{A}$	42	59	80	nC
$Q_{GS}$	Gate Source Charge		11	15	21	nC
$Q_{gd}$	Gate Drain("Miller") Charge		12	16	22	nC
<b>Switching Characteristics</b>						
$t_{d(on)}$	Turn-On DelayTime	$V_{GS} = 10\text{V}$ , $V_{DD} = 20\text{V}$ $I_D = 20\text{A}$ , $R_{GEN} = 3\Omega$	-	16	-	ns
$t_r$	Turn-On Rise Time		-	29	-	ns
$t_{d(off)}$	Turn-Off DelayTime		-	35	-	ns
$t_f$	Turn-Off Fall Time		-	13	-	ns
<b>Body Diode Characteristics</b>						
$I_S$	Maximum Continuous Body Diode Forward Current		-	-	223	A
$I_{SM}$	Maximum Pulsed Body Diode Forward Current		-	-	891	A
$V_{SD}$	Body Diode Forward Voltage	$V_{GS} = 0\text{V}$ , $I_S = 20\text{A}$	-		1.2	V
$t_{rr}$	Body Diode Reverse Recovery Time	$I_F = 20\text{A}$ , $di/dt = 100\text{A}/\mu\text{s}$	37	52	70	ns
$Q_{rr}$	Body Diode Reverse Recovery Charge		-	66	-	nC

- Notes:
1. Repetitive Rating: Pulse Width Limited by Maximum Junction Temperature.
  2.  $E_{AS}$  condition: Starting  $T_J = 25^\circ\text{C}$ ,  $V_{DD} = 20\text{V}$ ,  $V_{GS} = 10\text{V}$ ,  $R_G = 250\text{ohm}$ ,  $L = 3\text{mH}$ ,  $I_{AS} = 17.5\text{A}$ ,  $V_{DD} = 0\text{V}$  during time in avalanche.
  3.  $R_{\theta}$  is measured with the device mounted on a  $1\text{inch}^2$  pad of 2oz copper FR4 PCB.
  4. Pulse Test: Pulse Width  $\leq 3 \mu\text{s}$  &  $2 \mu\text{s}$   $\leq 0.5\%$ .





### Typical Performance Characteristics

Figure 1: Power De-rating

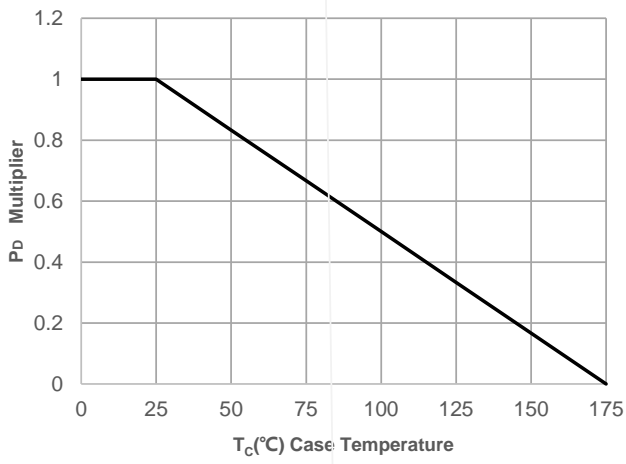
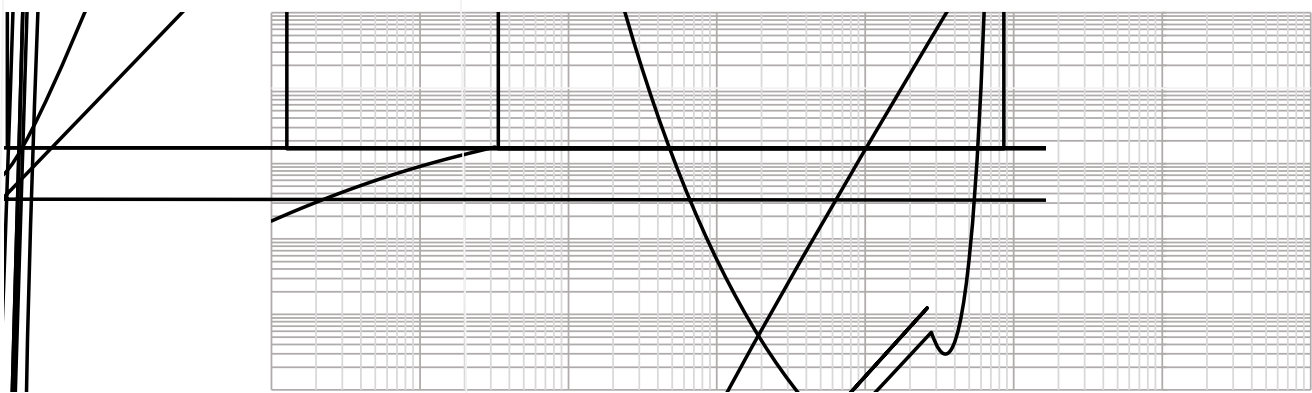
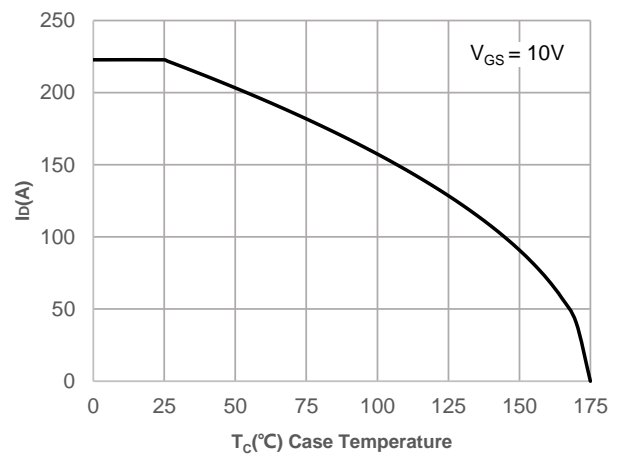

Figure 2: Current De-rating



## Typical Performance Characteristics

Figure 5: Output Characteristics

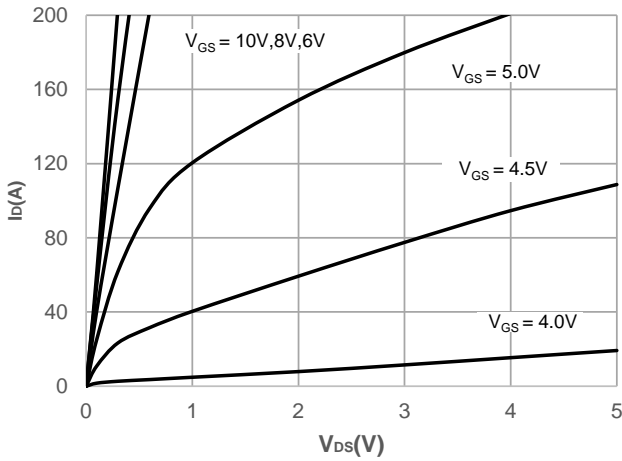

Figure 6: Typical Transfer Characteristics

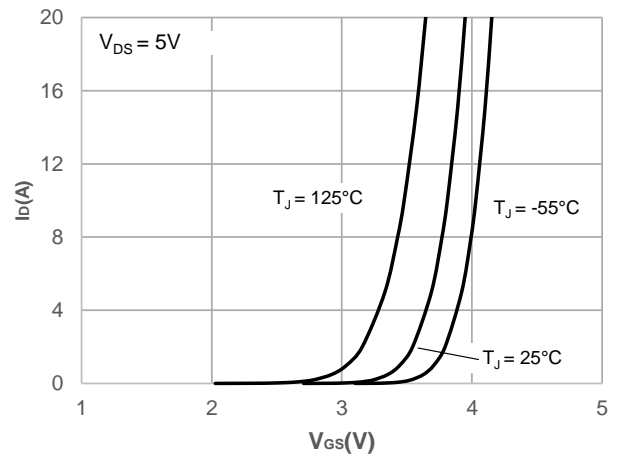

Figure 7: On-resistance vs. Drain Current

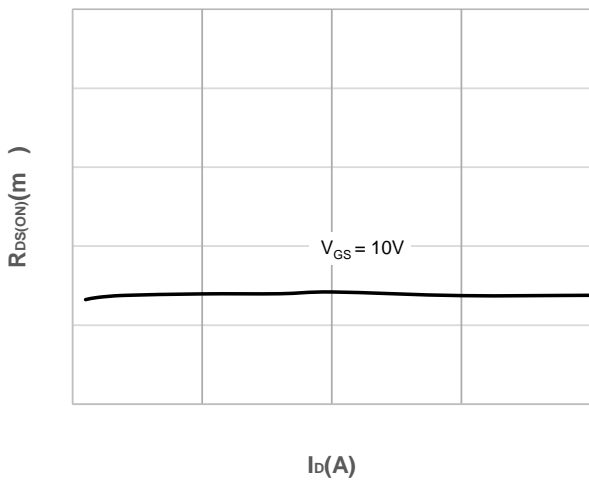

Figure 8: Body Diode Characteristics

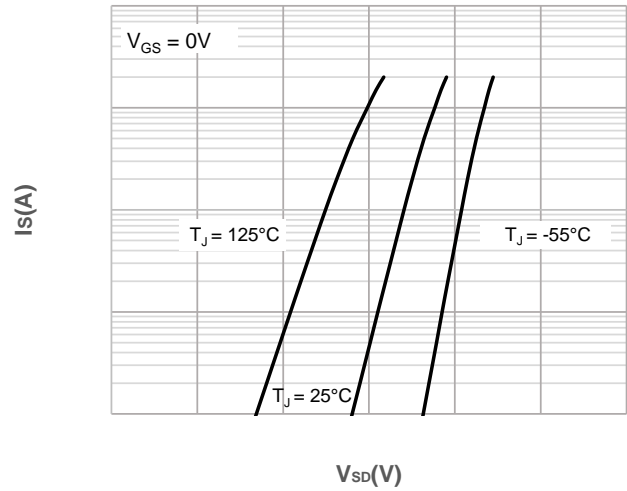

Figure 9: Gate Charge Characteristics

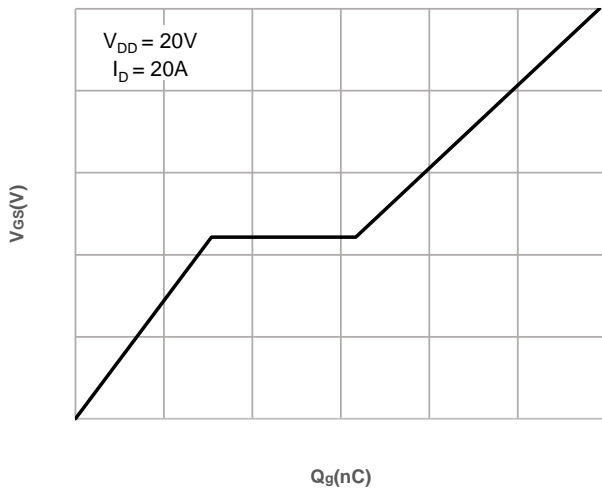
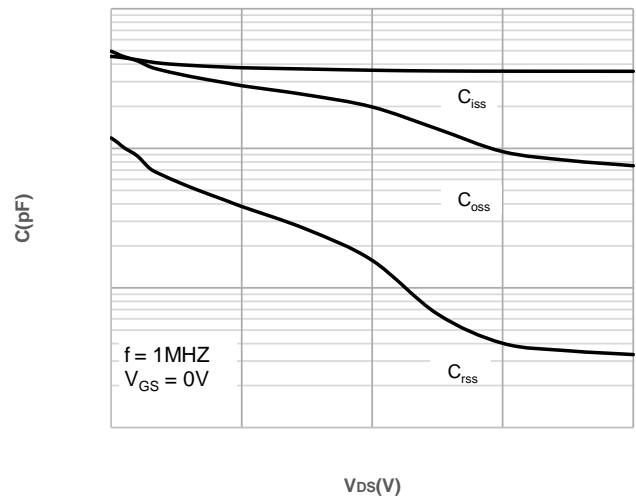

Figure 10: Capacitance Characteristics



### Typical Performance Characteristics

Figure 11: Normalized Breakdown voltage vs. Junction Temperature

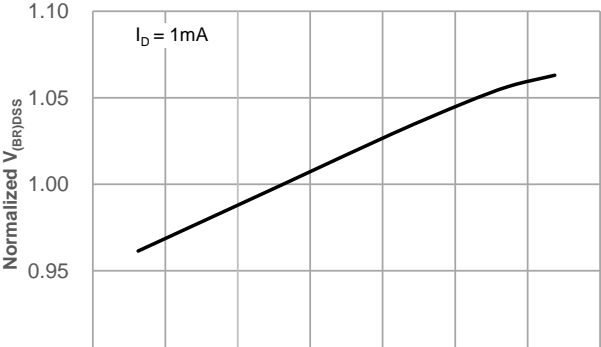

Figure 12: Normalized on Resistance vs. Junction Temperature

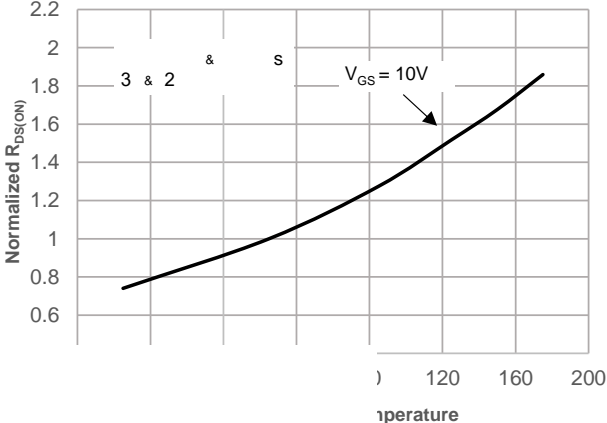
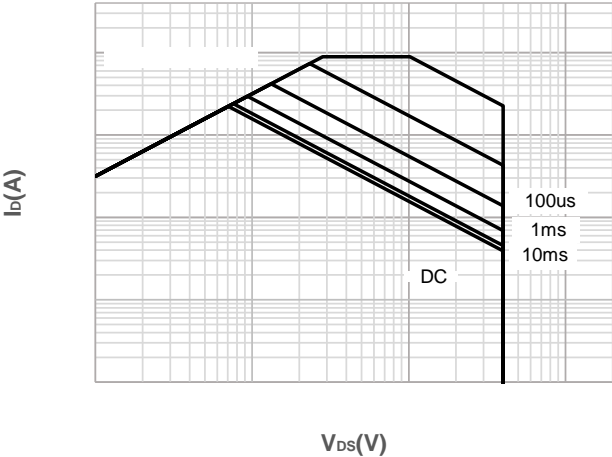

Figure 15: Maximum Safe Operating Area



Test Circuit



Figure 1: Gate Charge Test Circuit & Waveform

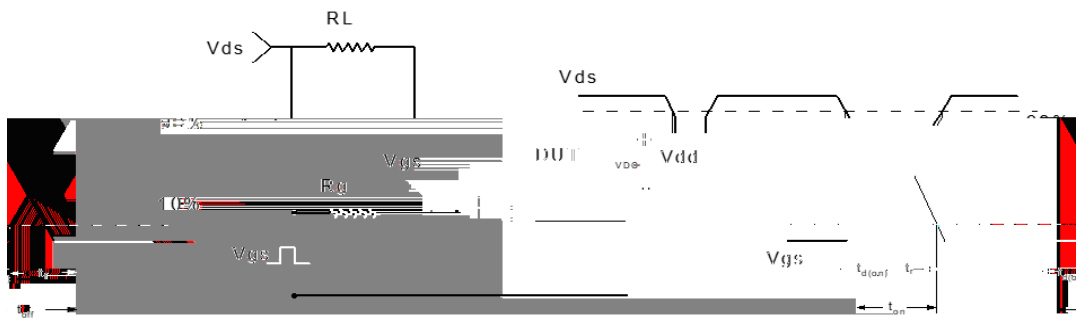

Figure 2: Resistive Switching Test Circuit & Waveform

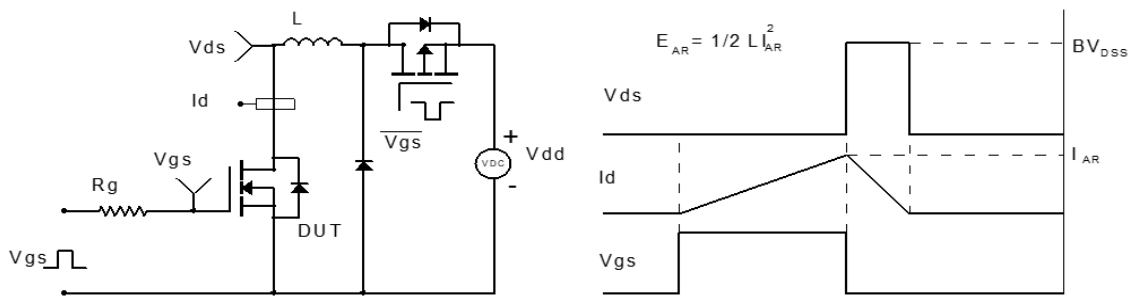

Figure 3: Unclamped Inductive Switching Test Circuit & Waveform

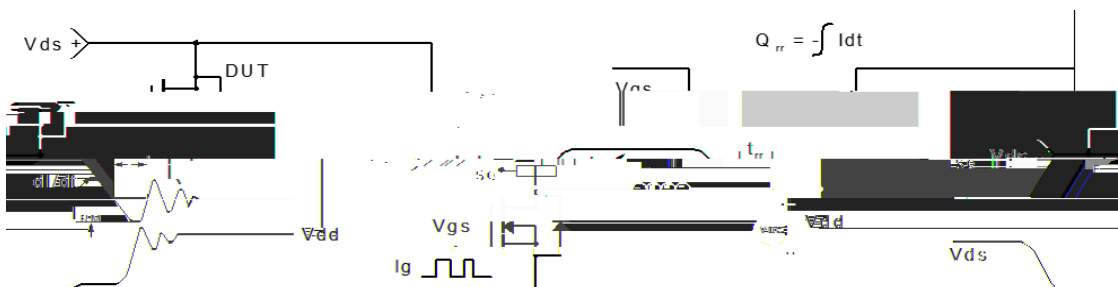
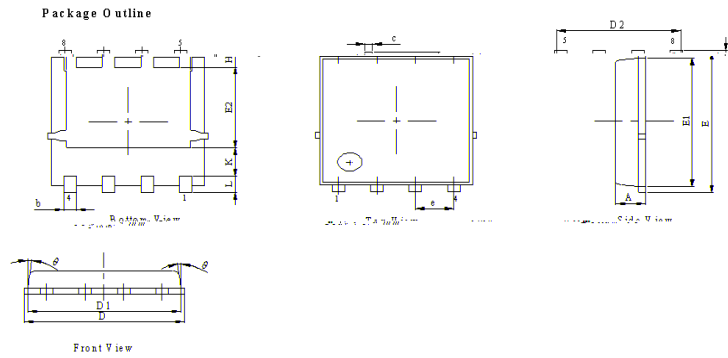

Figure 4: Diode Recovery Test Circuit & Waveform



## Package Mechanical Data(PDFN5X6-8L)



- NOTES:
1. Dimension and tolerance per ASME Y 14.5M, 1994.
  2. All dimensions in millimeter (angle in degree).
  3. Dimensions D1 and E1 do not include mold flash protrusions or gate burrs.

DIM.	MILLIMETER		
	MIN.	NOM.	MAX.
A	0.9	1	1.15
b	0.31	0.41	0.51
C	0.24	0.32	0.4
D	5	5.2	5.4
D1	4.95	5.05	5.15
D2	4	4.1	4.2
E	6.05	6.15	6.25
E1	5.5	5.6	5.7
E2	3.42	3.53	3.63
e	1.27BSC		
H	0.6	0.7	0.8
L	0.5	0.7	0.8
K	1.23 REF		
0			10

### Recommended Soldering Footprint

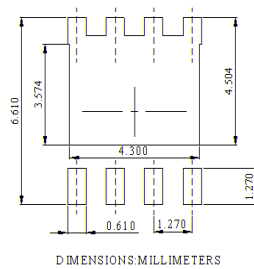

Information furnished in this document is believed to be accurate and reliable. However, Jiangsu JieJie Microelectronics Co.,Ltd assumes no responsibility for the consequences of use without consideration for such information nor use beyond it. Information mentioned in this document is subject to change without notice, apart from that when an agreement is signed, Jiangsu JieJie complies with the agreement. Products and information provided in this document have no infringement of patents. Jiangsu JieJie assumes no responsibility for any infringement of other rights of third parties which may result from the use of such products and information.

is a registered trademark of Jiangsu JieJie Microelectronics Co.,Ltd.