

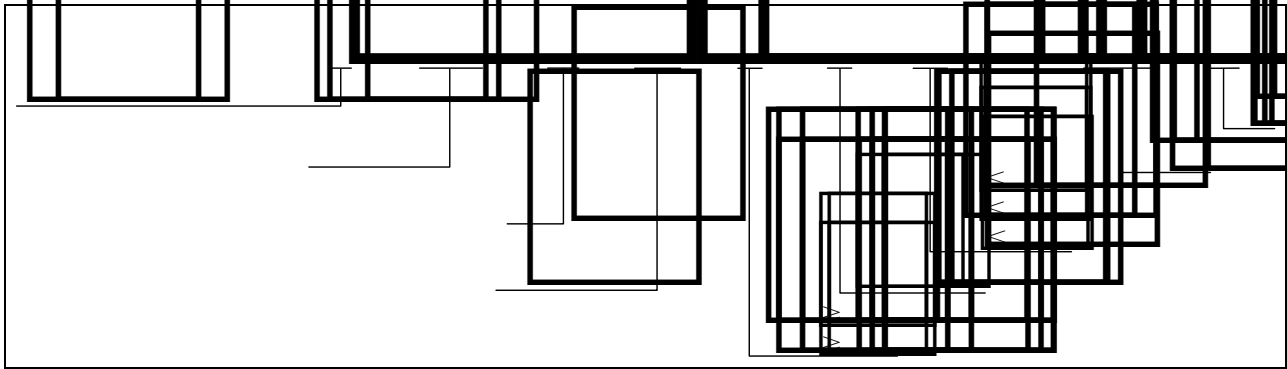

ORDERING INFORMATION



Packing Quantity	
Option	Quantity
DIP	60 Units/Tube
SMD	1200 Units/Reel

MARKING

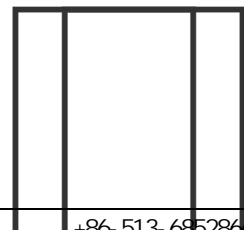
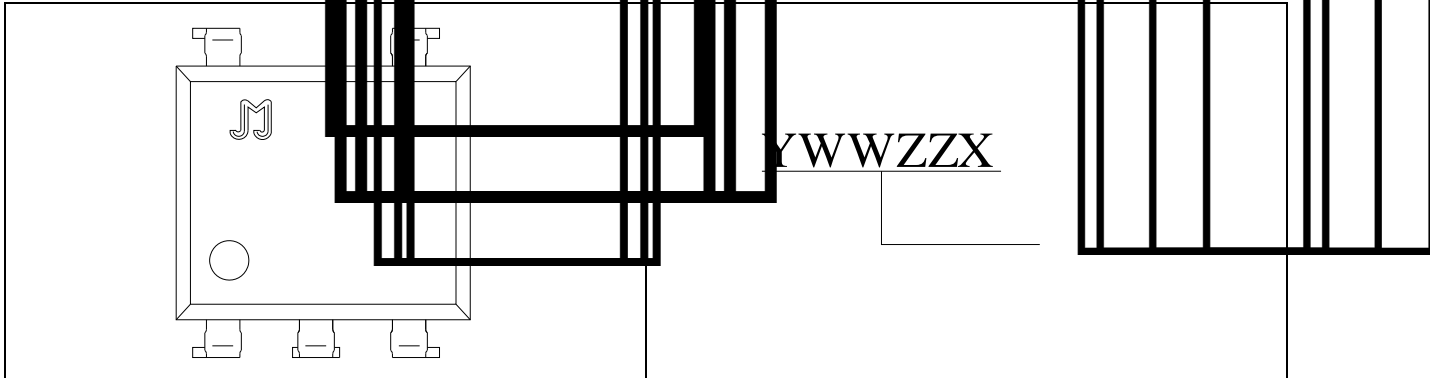

Characteristics Curves

FIG.1:

FIG.2:

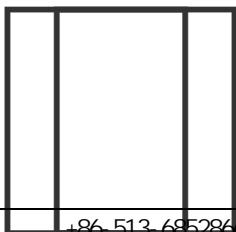
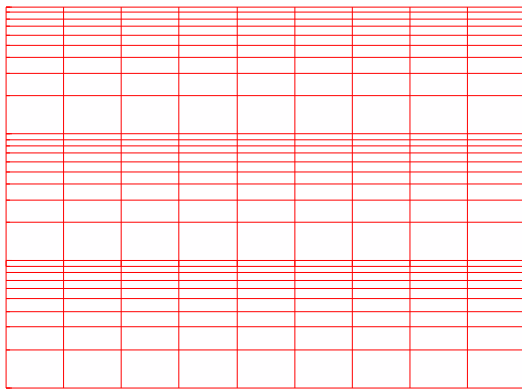
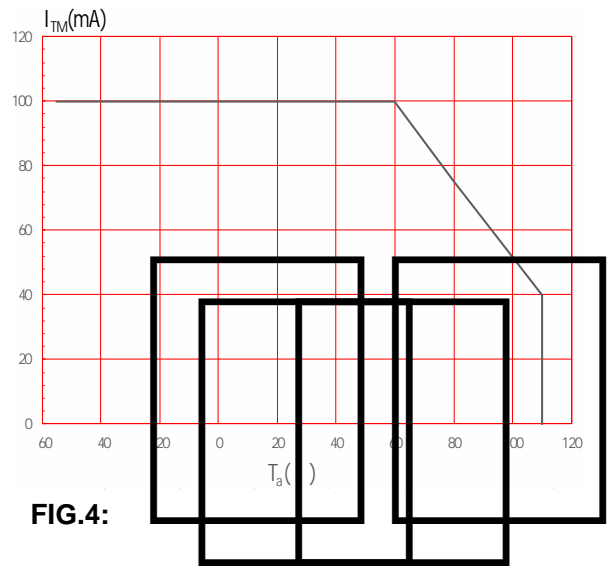
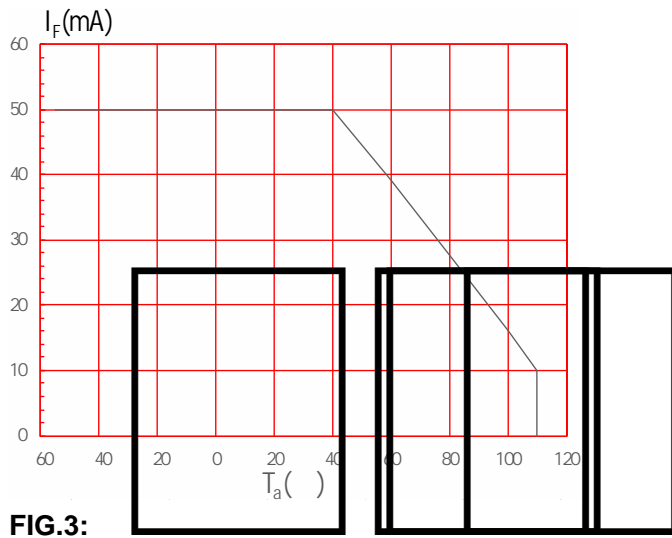

FIG.7:

FIG.8:

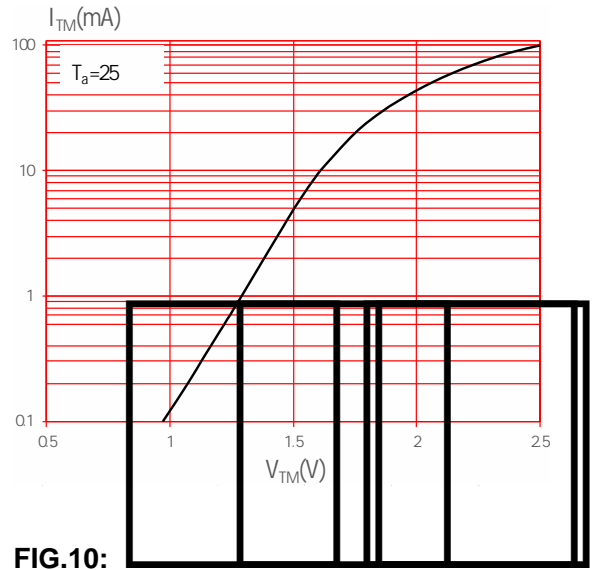
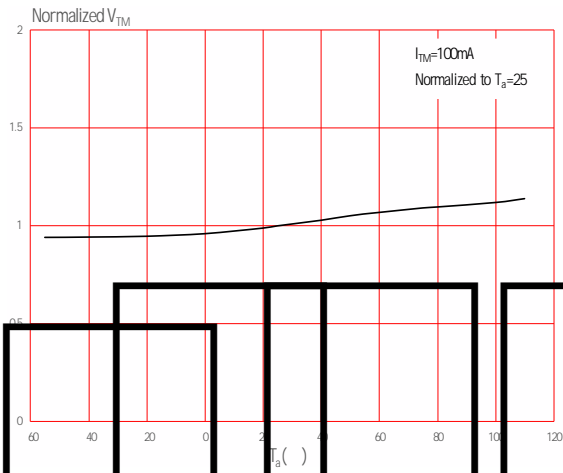

FIG.9:

FIG.10:

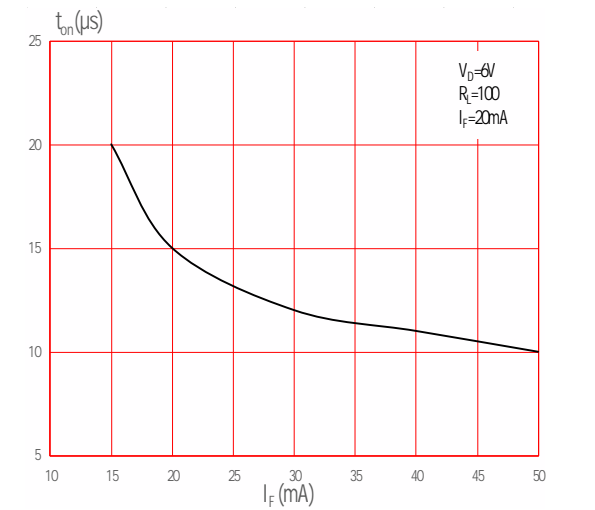
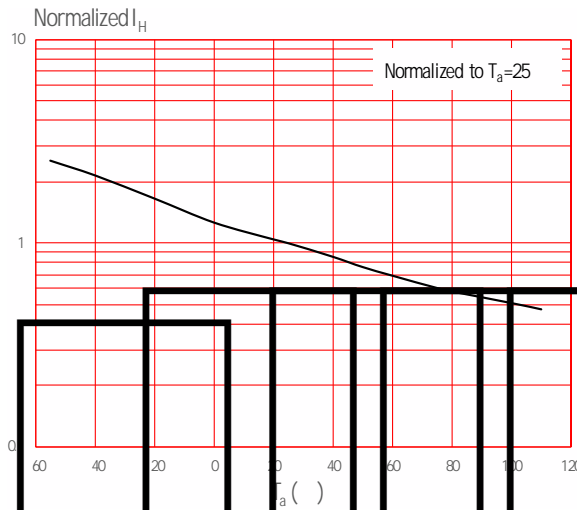

FIG.11:

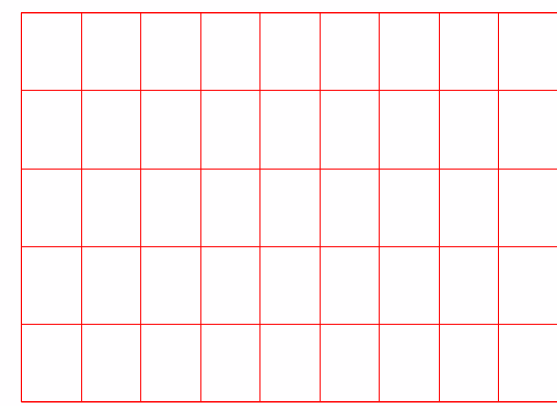

FIG.12:

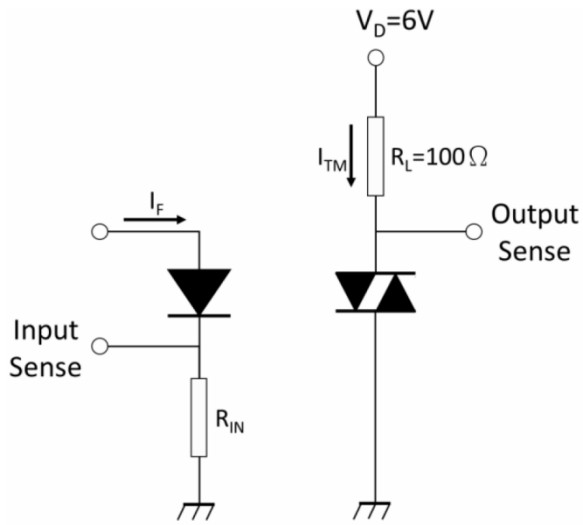

FIG.13:

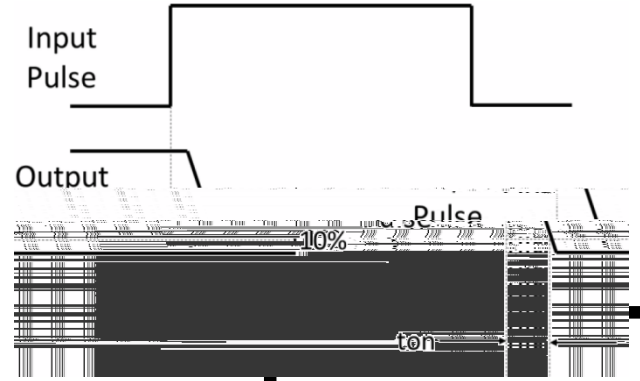

Fig.14: Test Circuits of dV/dt

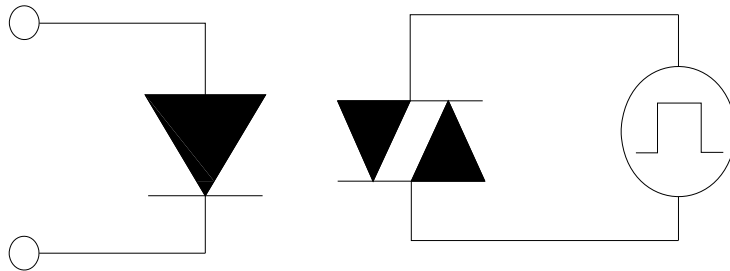

Fig.15: Waveforms of dV/dt

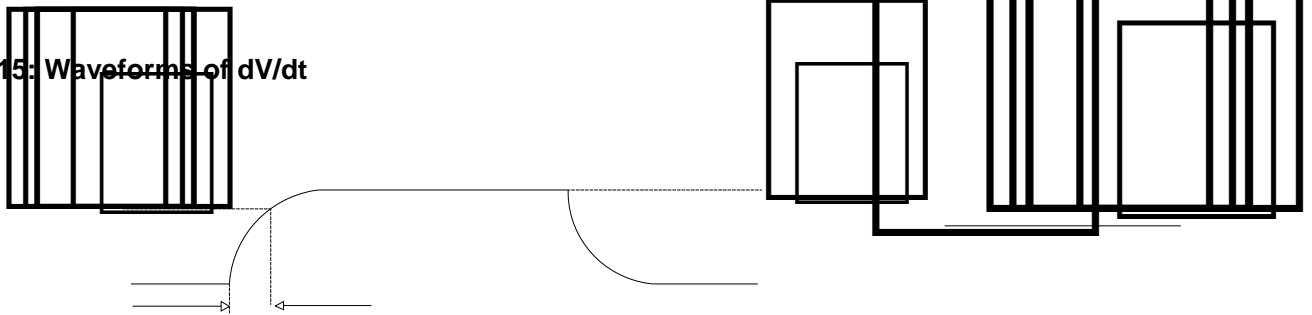
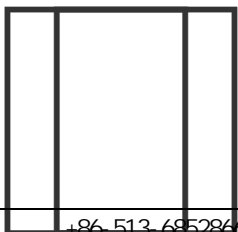
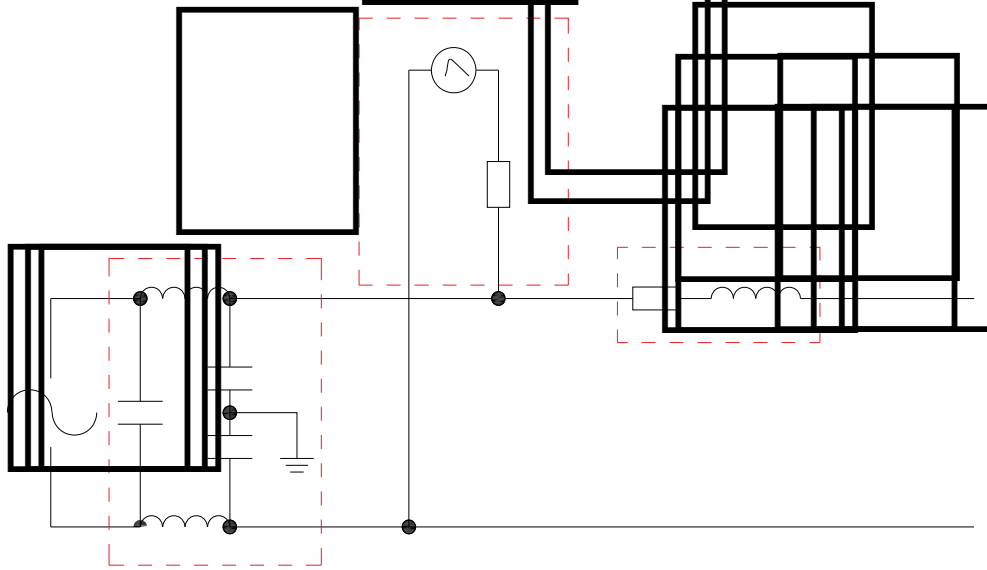
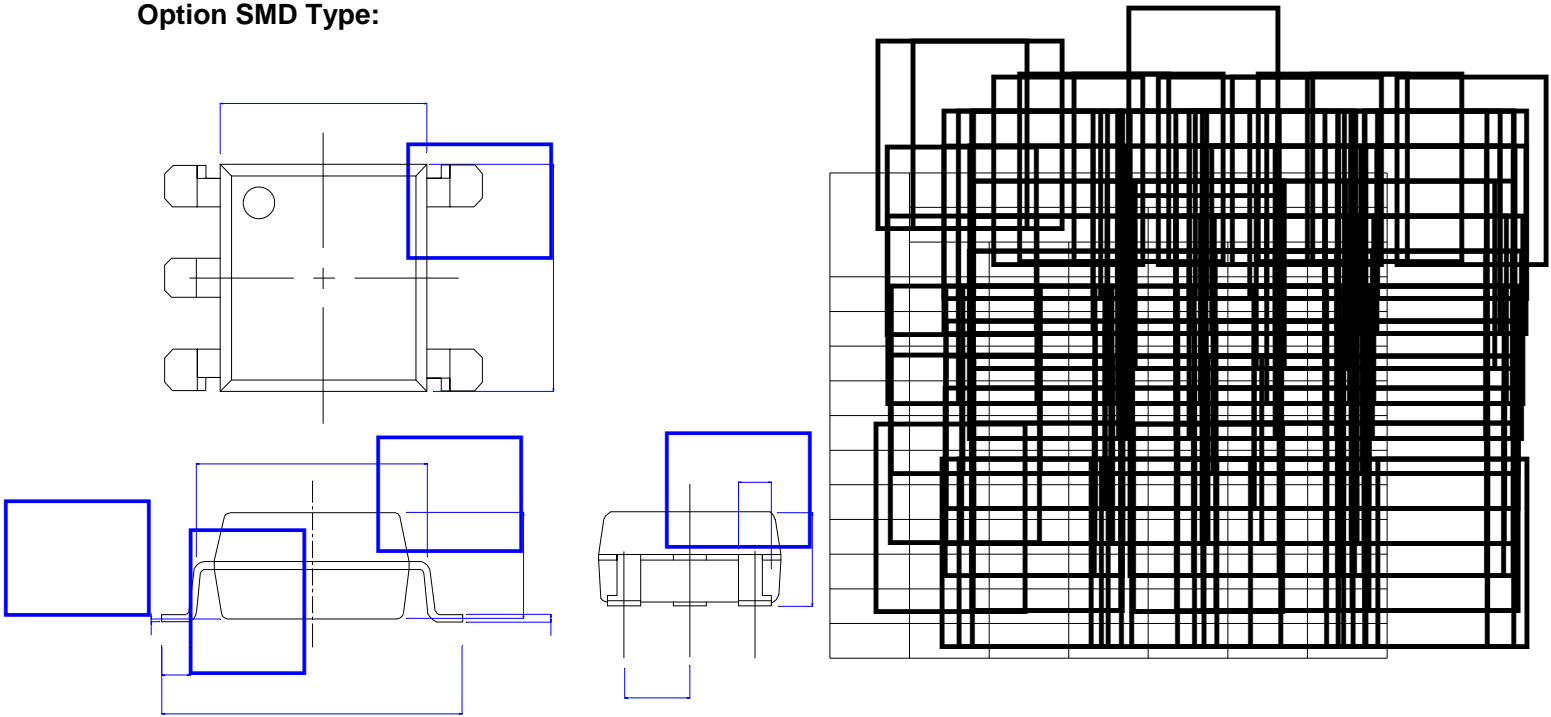



FIG.16:



Option SMD Type:



RECOMMENDED SOLDER MASK (Dimensions in mm unless otherwise stated)

Option SMD

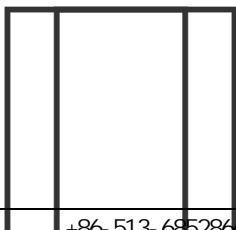
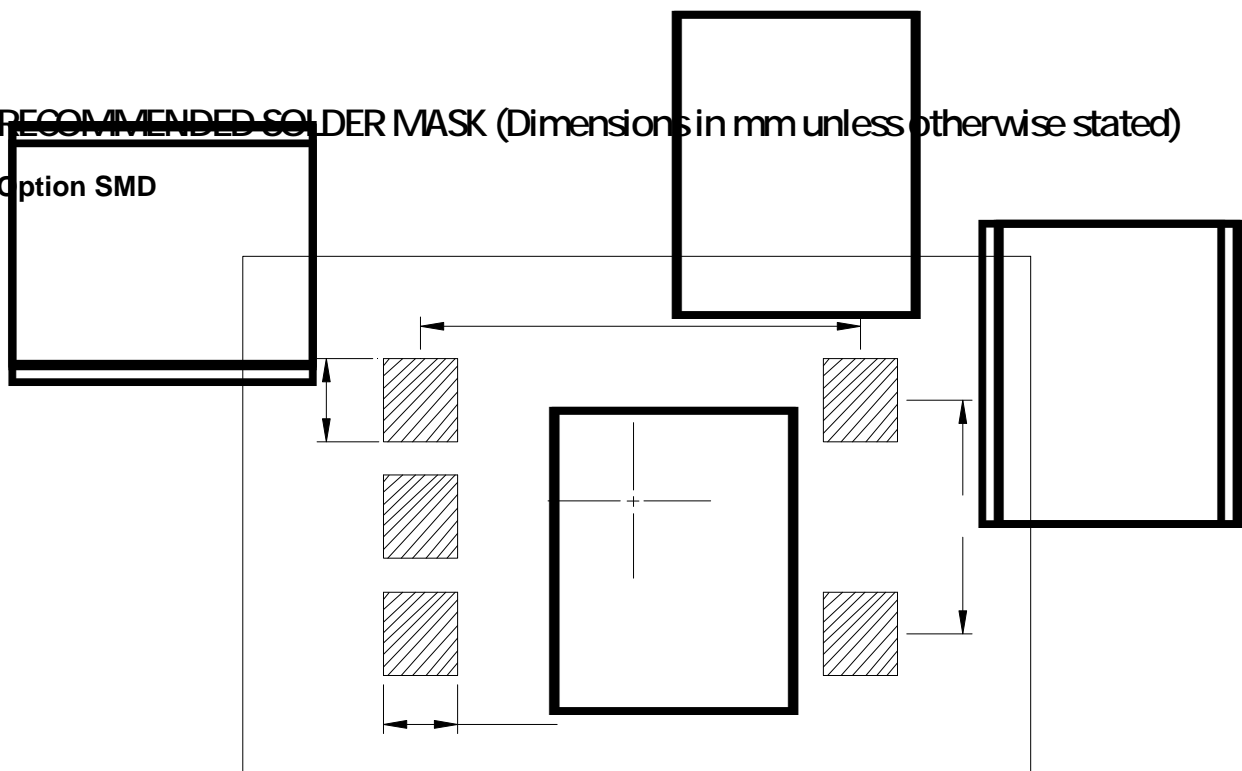

TUBE SPECIFICATIONS (Dimensions in mm unless otherwise stated)

Standard DIP

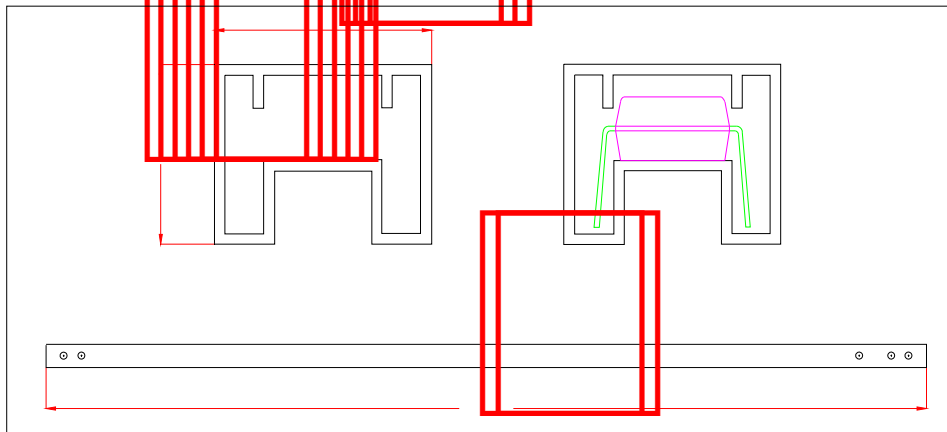

CARRIER TAPE SPECIFICATIONS (Dimensions in mm unless otherwise stated)

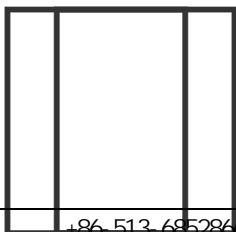
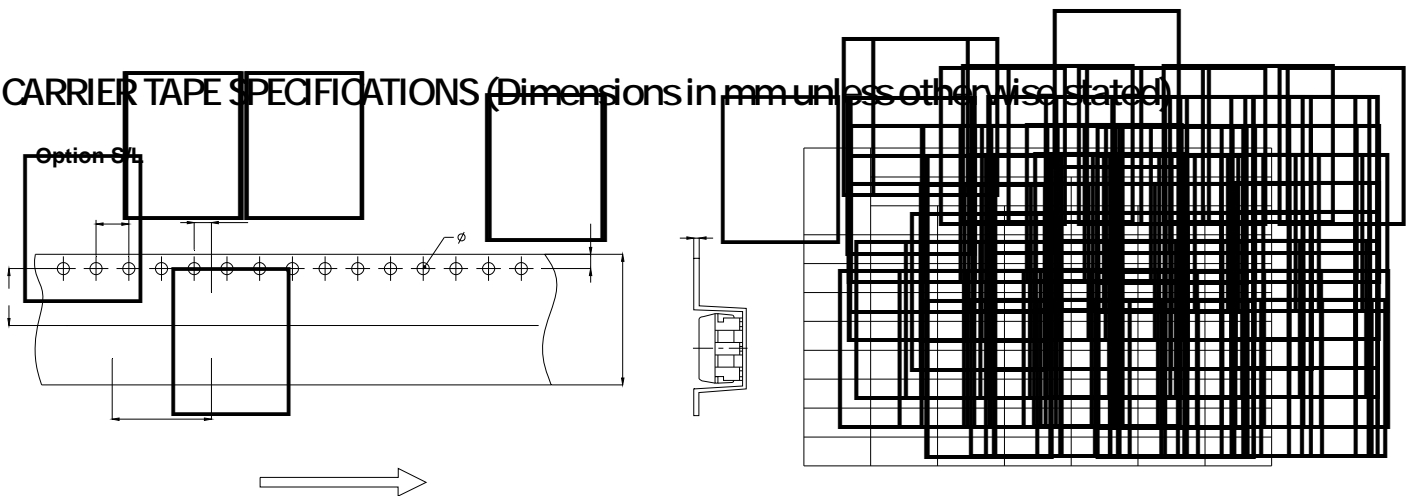

REFLOW INFORMATION

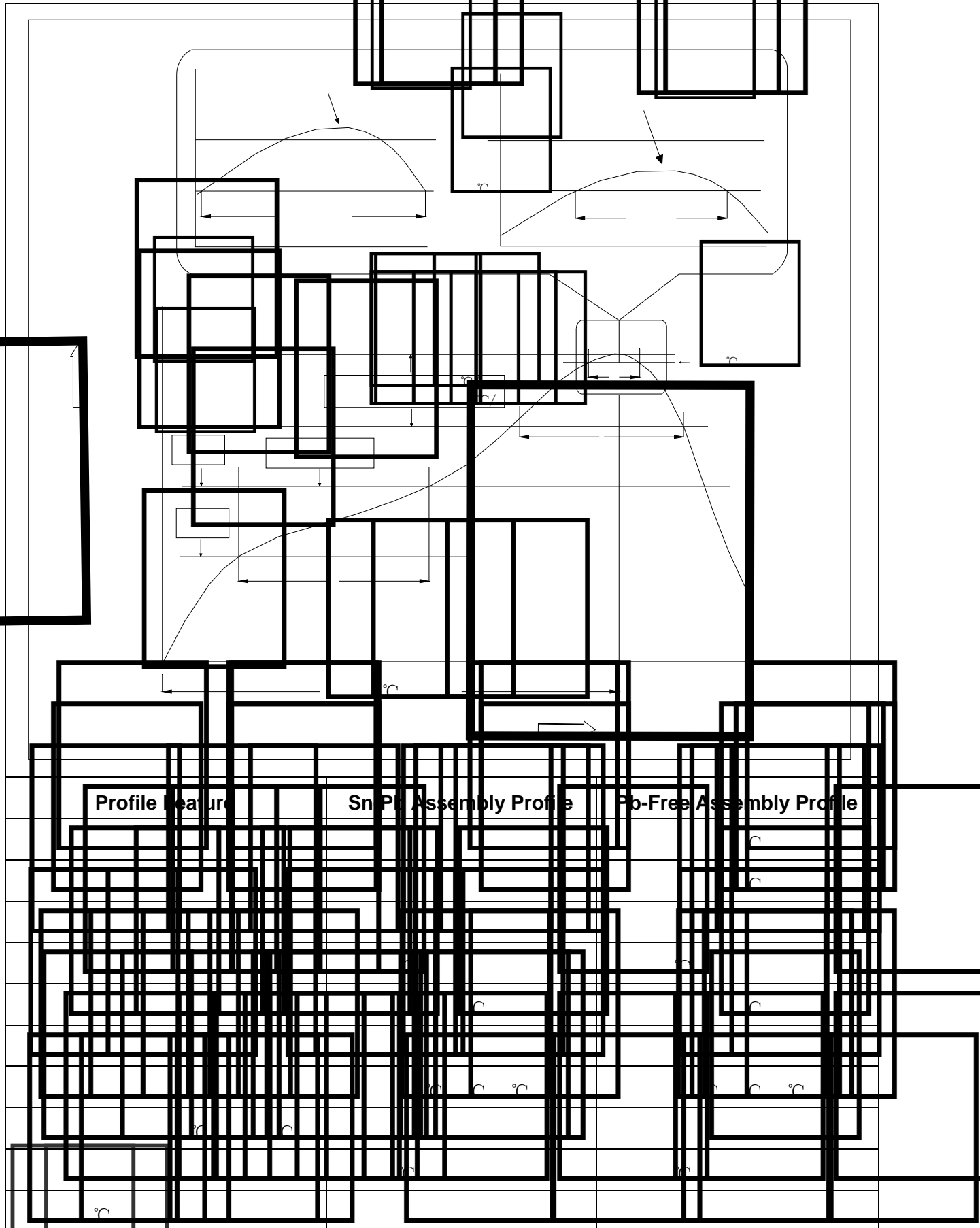

WAVE SOLDERING

