

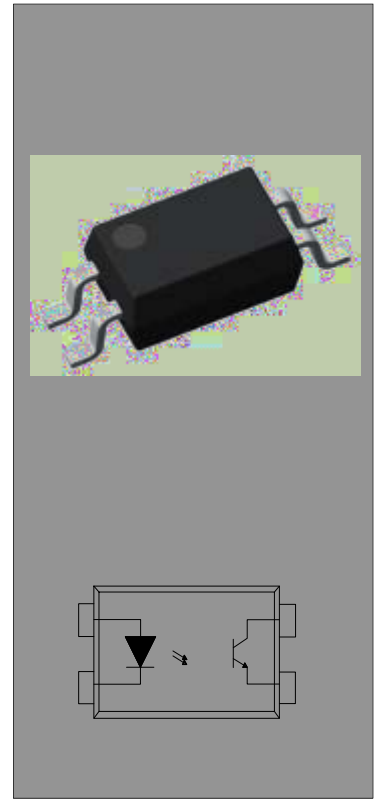

**DESCRIPTION:**



**MAIN FEATURES**

**ABSOLUTE MAXIMUM RATINGS**





NOTE1: 1  $\mu$ s pulse    NOTE2: AC for 1minute, R.H.=40-60%

### ELECTRICAL CHARACTERISTICS

NOTE1: Rank Table of Current Transfer Ratio (Temperature=25°C)

None	80	600
A	80	160
B	130	260
C	200	400
D	300	600
E	400	600
Q	100	200



## ORDERING INFORMATION

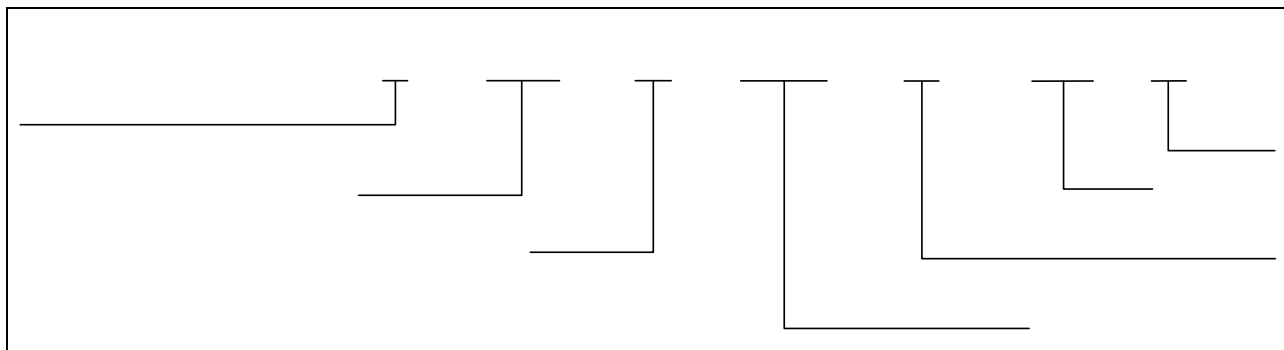

Packing Quantity	
Option	Quantity
None/R	3000 Units/Reel

## MARKING

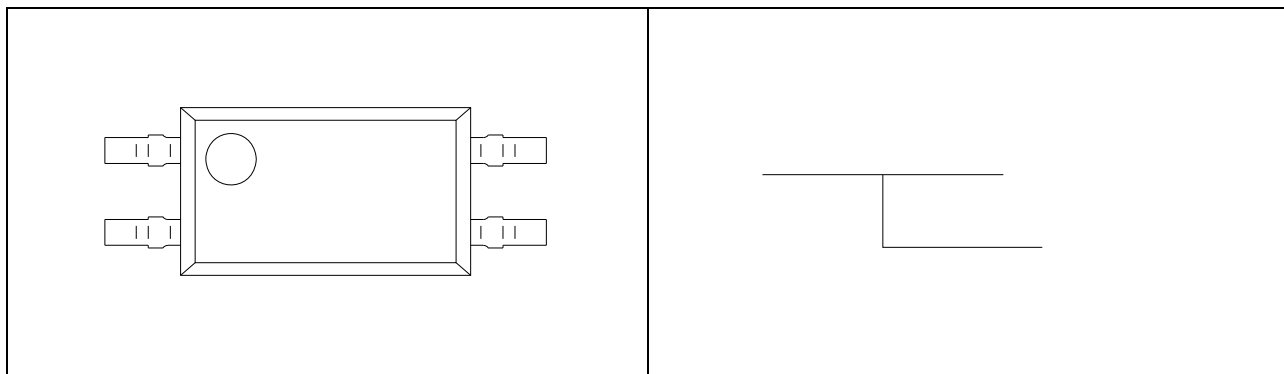



## Characteristics Curves

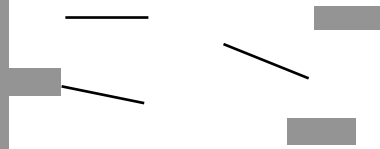
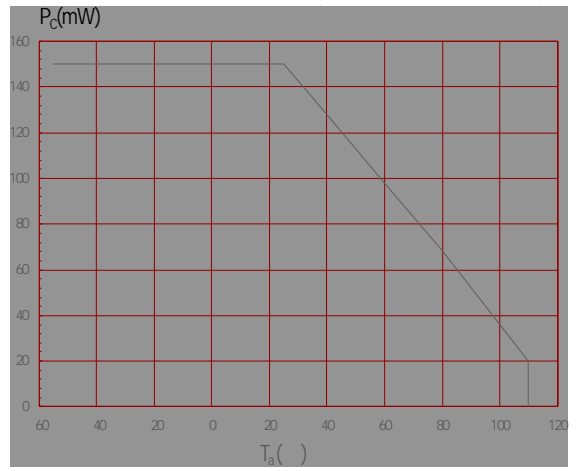
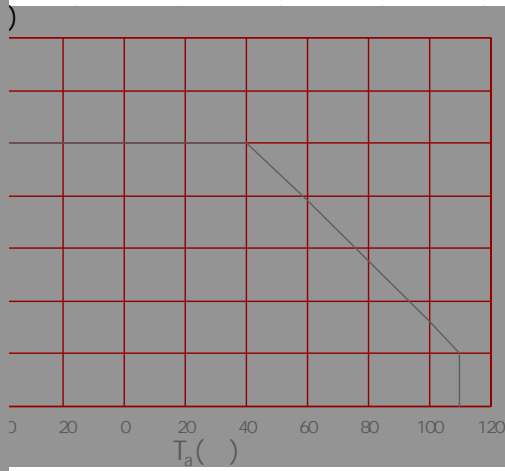

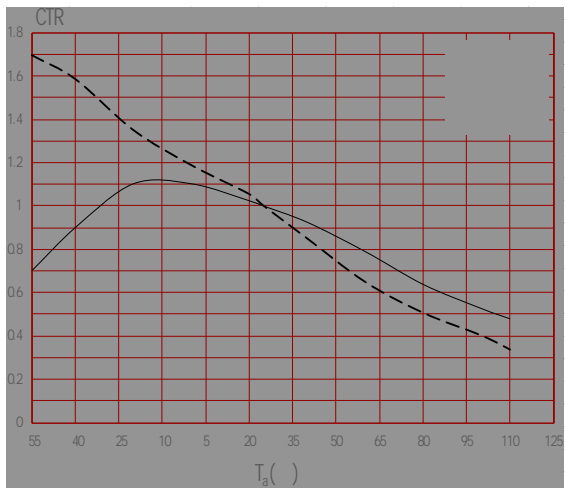



# Test Circuits

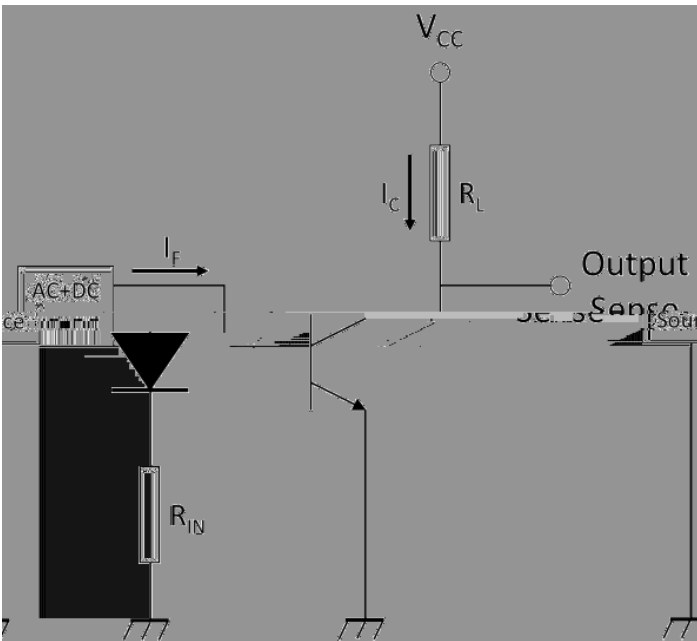
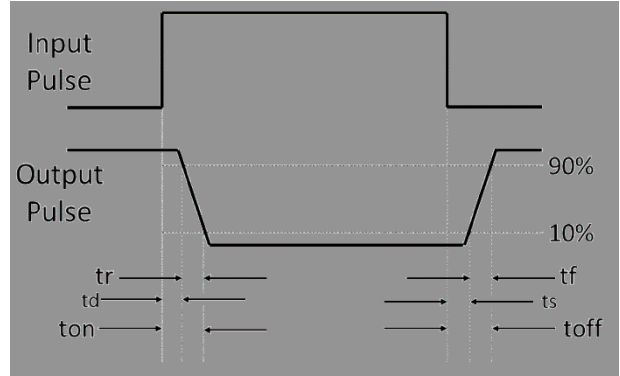
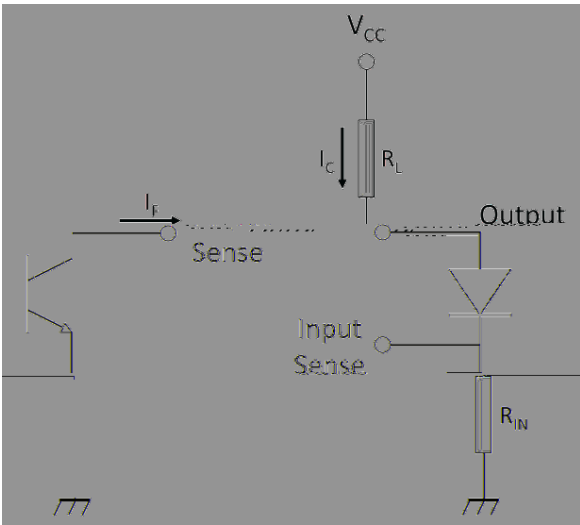



---

Package Dimension (Unit: mm)

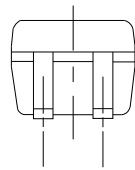
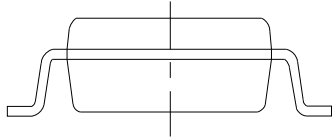
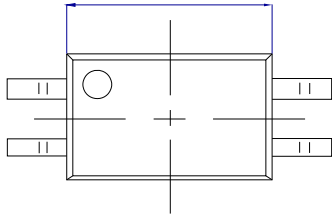



# CARRIER TAPE SPECIFICATIONS (Dimensions in mm unless otherwise stated)

Option None/R

